



# CONSTRUCTION & REPAIR OF CONCRETE WATER CONTAINMENT STRUCTURES



## CONSTRUCT WATERTIGHT STRUCTURES

Take the risk out of creating watertight tanks from the beginning by using Kryton's Krystol Internal Membrane™ (KIM®) admixture and Krystol Waterstop Joint System.

Waterproofing is built right into the concrete, eliminating the need for membranes. Kryton's Krystol® technology provides excellent resistance to harmful caustic effects of contact with sewage, wastewater and waterborne chemicals such as sulphates, chlorides and acids.

- Transform walls and slabs into impenetrable barriers using KIM or Krystol Broadcast™
- Create watertight construction joints and pipe penetrations using the Krystol Waterstop System

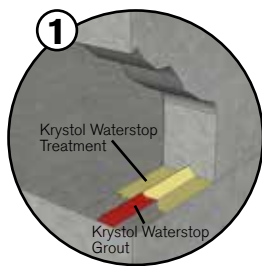
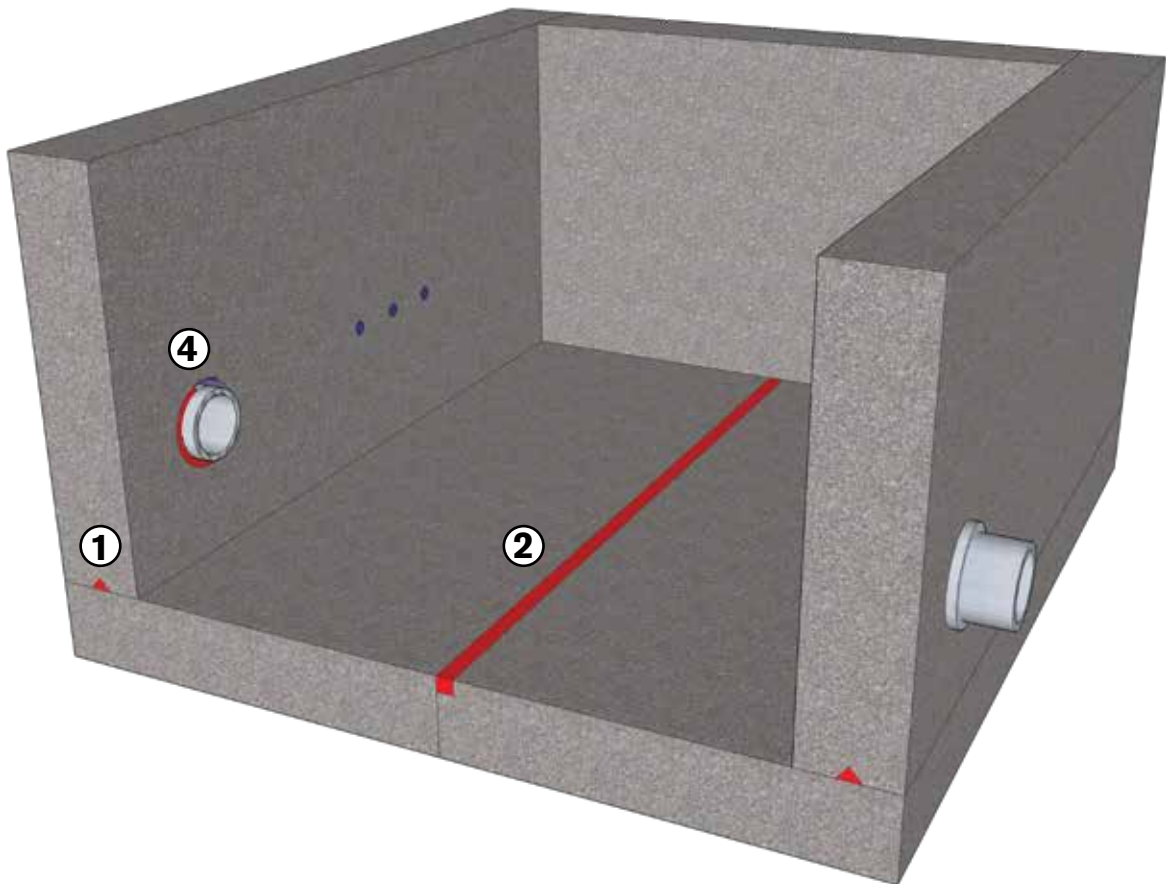

*Ensure watertight construction joints with the Krystol Waterstop System*

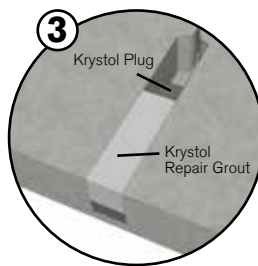
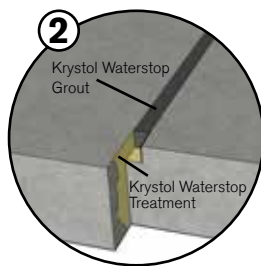

*Repair leaking cracks with the Krystol Leak Repair System*

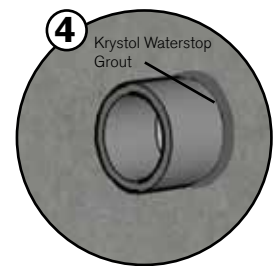

*Prevent leaks at pipe penetrations with Krystol products*



## REPAIR AND WATERPROOF EXISTING STRUCTURES

Extend the life of your existing structures by waterproofing where existing membranes have failed or where there was no initial waterproofing. Kryton's waterproofing and repair system is the only system that is as strong as concrete and works 100% of the time.

- Seal cracks and stop leaks using the Krystol Leak Repair System
- Use Krystol Plug™ and Krystol Repair Grout to treat leaking pipe penetrations
- Prevent further water ingress by applying Krystol T1 & T2 to walls and slabs subject to hydrostatic pressure

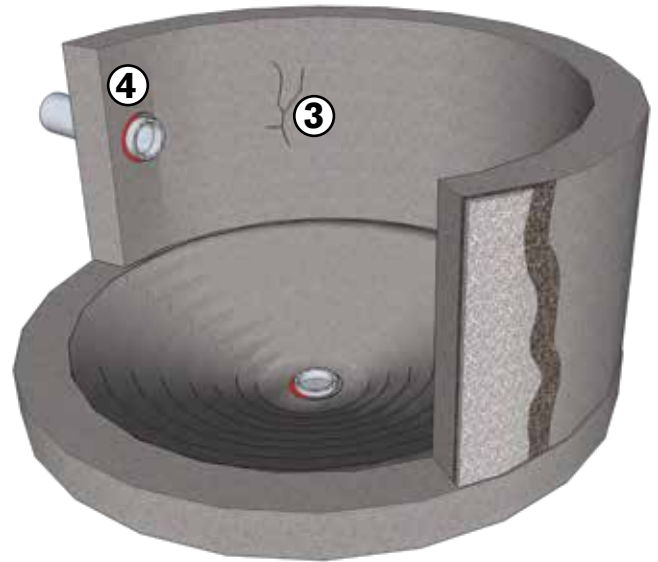
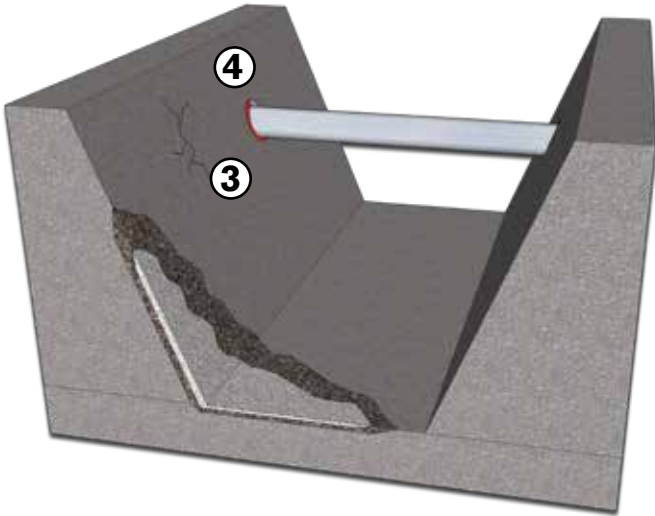

## REPAIRING THE BELENES WATER TANK



*Repair work on the Belenes water tank, Guadalajara, Mexico*

The Belenes water containment tank was built 10 years ago, but had never been put into use. It needed a major re-surface treatment. There were cracks in the walls and in the slab. The tie holes needed waterproofing treatment. Major repair was needed to ensure a dependable and safe source of drinking water was available.

The government body charged with supplying potable water and sewer services to the Jalisco region, SIAPA, had previous experience with an innovative product manufactured by Kryton which was used for waterproofing concrete. Two years previously, SIAPA's technical director gave Kryton a real-life trial by seeing if their integral crystalline waterproofing could repair SIAPA's water tank in nearby Mesa Colorada. Delighted with the outcome, SIAPA included Kryton's integral crystalline admixture and repair system in its specifications for all future concrete repair and construction projects.

The project used Kryton's Krystol Leak Repair System, followed by a coating of Krystol T1 over the entire tank. Not only does the Krystol system ensure that the Belenes water tank will be waterproof, the Krystol line of products are also certified safe for contact with potable water by NSF International (certified to NSF/ANSI std. 61) and have zero volatile organic compounds (VOCs).



*TreePeople Center Underground Cistern,  
Los Angeles, California, USA*

TreePeople, is a non-profit organization that provides sustainable solutions to urban ecosystem problems. The center features a 216,000-gallon underground concrete cistern designed to achieve the US Green Building Council's Leadership in Energy and Environmental Design (LEED) Platinum Rating. Because conventional waterproofing membranes deteriorate over time the center's owners opted to use Kryton's Krystol Internal Membrane (KIM) and the Krystol Waterstop System for joints. By eliminating costly repairs and maintenance, KIM provides worry-free waterproofing for the life of the cistern.

In 2011 Kryton was awarded Project of the Year in the GreenSite Awards for their work on the TreePeople cistern.



*Annacis Island Wastewater Treatment Plant,  
Vancouver, British Columbia, Canada*

Annacis Island Wastewater Treatment Plant (WWTP) is the largest WWTP in the Greater Vancouver area and provides secondary wastewater treatment to approximately 1 million people. Four huge DAFT tanks, several meters in height and 400 mm (15 in.) thick were cracking and leaking. Kryton-approved applicators were contracted to provide repairs to leaking tanks and other walls at the facility. Krystol Bari-Cote, Krystol T1 & T2 were used to repair and waterproof the tanks.

When Annacis Island expanded their facilities, the Krystol Internal Membrane (KIM) admixture was used for waterproofing base slabs and walls in place of a membrane and bentonite at the deepest locations on-site – three stories below the water table.



*Batu Kitang Water Treatment Facility Complex,  
Batu Kitang , Kuching, Malaysia*

Due to the growing population the Kuching Water Board needed to expand their fresh water and they needed to do it quickly. The board elected to add to the complex by building an eighth module, which would increase the facility's fresh water producing capacity by 100 million liters per day. With a timeline projected of a year and a half, speed and efficiency of construction were critical. Another important factor in construction was waterproofing as the structure would be exposed to high water pressure being constantly pumped in and out of the plant. The team used Kryton's Krystol Internal Membrane (KIM), Krystol Waterstop System and Krystol T1 to keep the structure leak-free and meet their tight construction schedule.

Offices in Canada, USA, UK, Singapore, China, India, and Dubai. Plus, with over 50 distributors worldwide, there is a Kryton distributor near you.

Find yours today: [www.kryton.com](http://www.kryton.com)



**Kryton International Inc.**

1645 East Kent Avenue  
Vancouver, BC Canada V5P 2S8  
Tel: 1.604.324.8280  
Fax: 1.604.324.8899  
Toll Free (Canada/USA):  
1.800.267.8280  
Email: [info@kryton.com](mailto:info@kryton.com)



**SMART CONCRETE®**